



Inductive sensor NBN40-L2-B3-V1

- Sensor head bidirectional and rotatable
- Basic series
- NO/NC programmable
- Adjustable sensor head
- Oscillator monitoring
- On/Off delay (disconnectable)



Dimensions

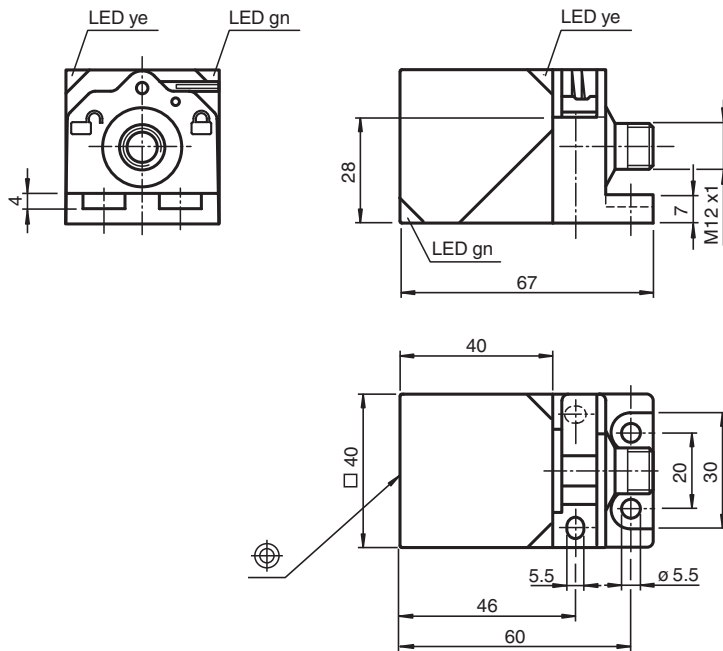

Technical Data

General specifications

Switching function		Normally open/closed (NO/NC) programmable
Output type		AS-Interface
Rated operating distance	s_n	40 mm
Installation		non-flush
Assured operating distance	s_a	0 ... 32.4 mm
Reduction factor r_{Al}		0.3
Reduction factor r_{Cu}		0.3
Reduction factor r_{304}		0.75
Node type		Standard node

Release date: 2023-06-14 Date of issue: 2023-06-14 Filename: 226320_eng.pdf

Refer to "General Notes Relating to Pepperl+Fuchs Product Information".

Pepperl+Fuchs Group
www.pepperl-fuchs.com

USA: +1 330 486 0001
fa-info@us.pepperl-fuchs.com

Germany: +49 621 776 1111
fa-info@de.pepperl-fuchs.com

Singapore: +65 6779 9091
fa-info@sg.pepperl-fuchs.com

PF PEPPERL+FUCHS

Technical Data

AS-Interface specification		V2.1
Required gateway specification		≥ V2.1
Output type		2-wire
Nominal ratings		
Operating voltage	U_B	26.5 ... 31.9 V via AS-i bus system
Switching frequency	f	0 ... 50 Hz
Hysteresis	H	typ. 5 %
Reverse polarity protection		reverse polarity protected
No-load supply current	I_0	≤ 40 mA
Time delay before availability	t_v	≤ 1000 ms
Operating voltage indicator		LED, green
Switching state indicator		LED, yellow
Functional safety related parameters		
MTTF _d		1330 a
Mission Time (T _M)		20 a
Diagnostic Coverage (DC)		0 %
Compliance with standards and directives		
Standard conformity		
Standards		EN 60947-5-2:2007 IEC 60947-5-2:2007
Approvals and certificates		
UL approval		cULus Listed, General Purpose
CSA approval		cCSAus Listed, General Purpose
CCC approval		CCC approval / marking not required for products rated ≤36 V
Ambient conditions		
Ambient temperature		-25 ... 70 °C (-13 ... 158 °F)
Storage temperature		-40 ... 85 °C (-40 ... 185 °F)
Mechanical specifications		
Connection type		Connector plug M12 x 1 , 4-pin
Housing material		PA
Sensing face		PA
Degree of protection		IP69K

Connection

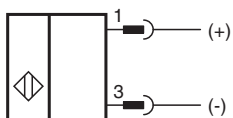

Connection Assignment

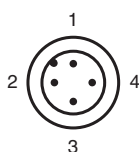

Additional Information

Programming Instructions

Address 00 preset, alterable via Busmaster or programming units

IO-Code 1
ID-Code 1
ID1-Code F
ID2-Code F

Data bit





Bit	Function
D0	switching state ¹⁾ (0 = damped; 1 = undamped)
D1	not used
D2	oscillator monitoring (0= oscillator defective, 1=normal operation)
D3	not used

Parameter bit

Bit	Function
P0	ON / Off delay activated* / deactivated
P1	switching element function ²⁾ (0 = NC; 1 = NO)
P2	not used
P3	not used

- ¹⁾ Applies to NO funktion (P1 = 1; preset),
with NC funktion (P1 = 0) reversed characteristics
²⁾ Default setting: NO

Accessories

	V1-W-2M-PUR	Female cordset single-ended M12 angled A-coded, 4-pin, PUR cable grey
	V1-G-2M-PUR	Female cordset single-ended M12 straight A-coded, 4-pin, PUR cable grey
	MHW 01	Modular mounting bracket
	MH 02-L	Mounting aid for VariKont-L

Release date: 2023-06-14 Date of issue: 2023-06-14 Filename: 226320_eng.pdf

Refer to "General Notes Relating to Pepperl+Fuchs Product Information".

Pepperl+Fuchs Group
www.pepperl-fuchs.com

USA: +1 330 486 0001
fa-info@us.pepperl-fuchs.com

Germany: +49 621 776 1111
fa-info@de.pepperl-fuchs.com

Singapore: +65 6779 9091
fa-info@sg.pepperl-fuchs.com

 **PEPPERL+FUCHS**

Operation

Indication depending on the operation mode

Symptoms	green LED (POWER)	red LED (FAULT)	Data bit D2
normal operation	on	off	1
Oscillator defect	flashing	flashing	0
no communication	off	on	1

On/off delay:

The on/off delay is preset and switched on (P0=1). On delay approx. 15 ms, when P0=1 and NO function (P1=1). Off delay approx. 15 ms, when P0=1 and NC function (P1=0).